

Lirika

Type SUP041E

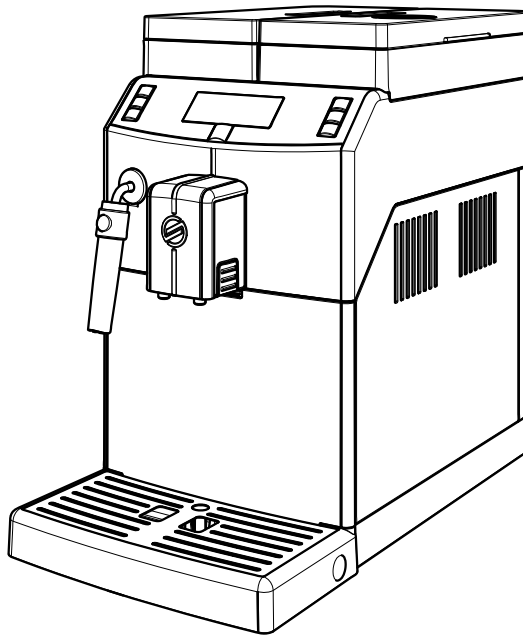

EN

02

OPERATING INSTRUCTIONS

Read these operating instructions carefully before using the machine.

CE

 **Saeco**

1

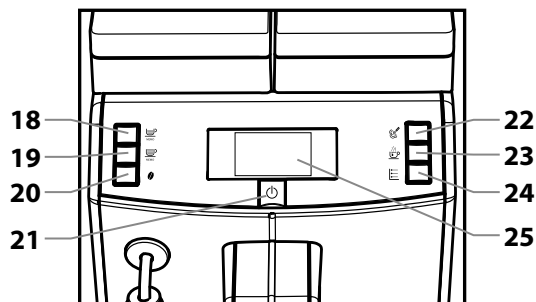
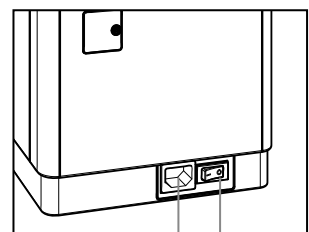
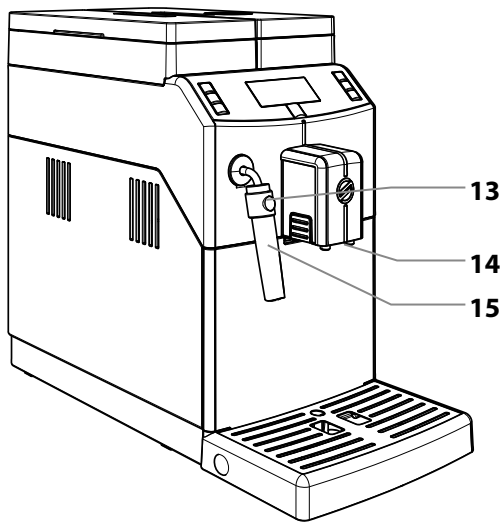
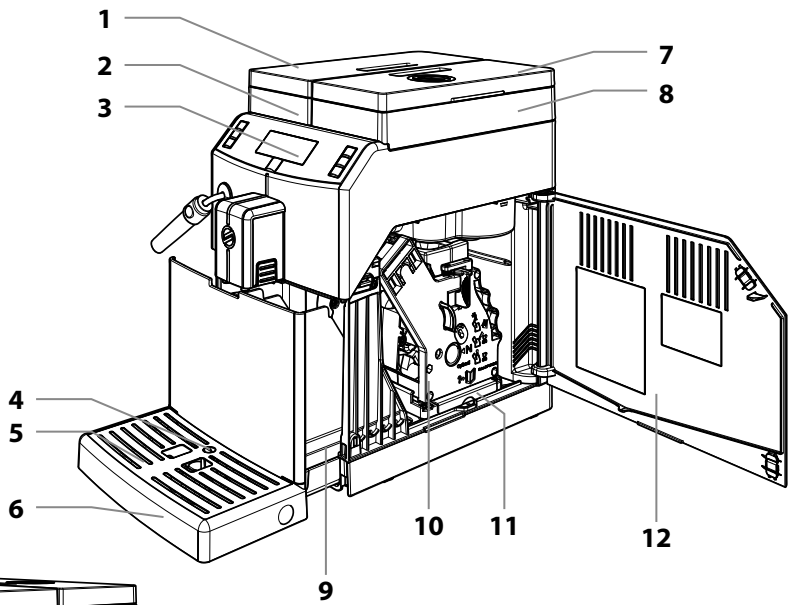

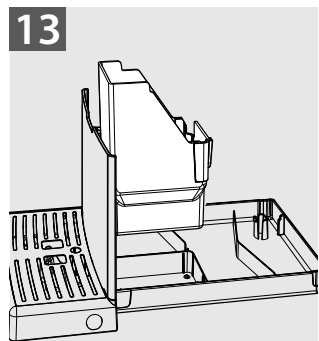
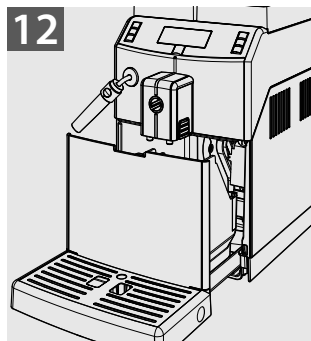
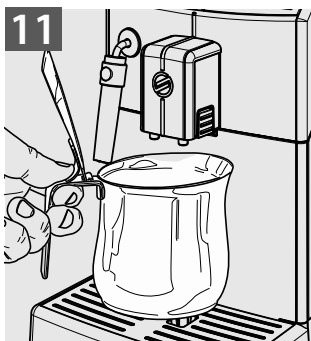
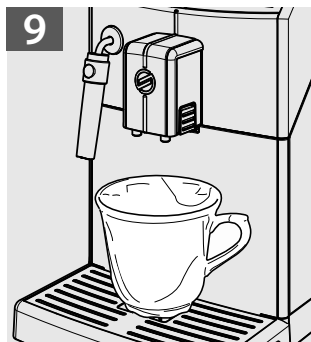
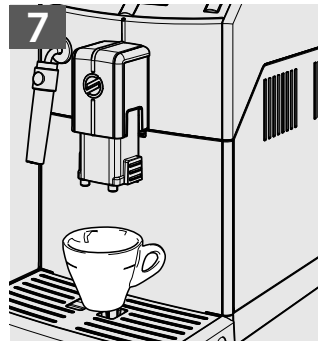
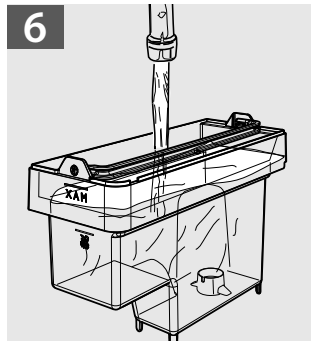
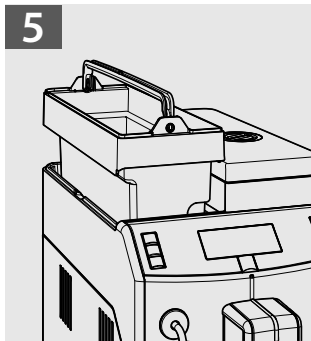
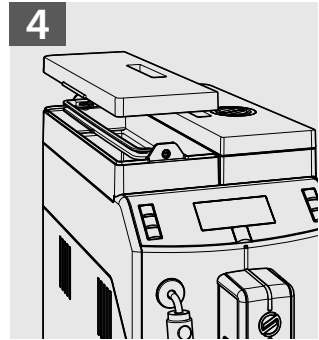
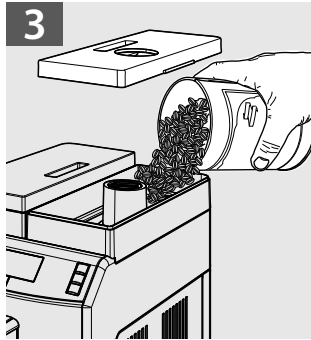
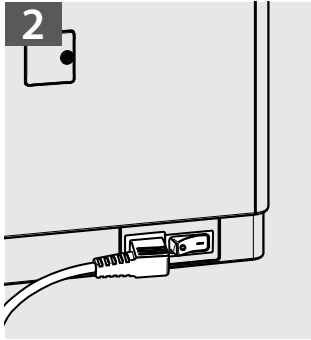

SAFETY INSTRUCTIONS



Never allow water to come into contact with any of the electrical parts of the machine: danger of short circuit! Hot water and steam may cause scalding!

Intended Use

The machine is intended to be used in small offices/organisations only.

The appliance is not to be used by persons (including children) with reduced physical, mental or sensory abilities or with scarce experience and/or expertise, unless they are supervised by a person responsible for their safety, or they are instructed by this person on how to properly use the machine.

Power Supply

The machine must be connected to the power supply by the service provider, in accordance with its specifications.

Power Cord

Never use the machine if the power cord is defective.

Report any defects in the cord and/or plug to the service provider immediately. Do not pass the power cord around corners, over sharp edges or over hot objects and keep it away from oil. Do not use the power cord to carry or pull the machine. Do not pull out the plug by the power cord or touch it with wet hands

or feet. Do not let the power cord hang freely from tables or shelves.

For the Safety of Others

Ensure that children cannot play with the machine and/or the packaging materials. Never direct the jet of hot water and/or steam towards yourself or others. Do not touch the hot water wand with bare hands. Always use the handles or knobs provided.

Danger of Burns

Do not touch the hot water wand and/or the coffee/beverage dispensing spout.

Fire Safety Precautions

In case of fire, use carbon dioxide (CO₂) extinguishers. Do not use water or dry powder extinguishers.

Suitable Location for Operation and Maintenance

The machine should be installed by the service provider in accordance with the safety regulations in force at the time of installation.

The machine may only be moved by the service provider.

Do not use the machine outdoors.

Avoid placing open flames and/or incandescent objects near the machine so as not to damage or melt the machine housing. Do not use in places where the temperature may drop to a level equal to and/or lower than 0°C. If the machine has been exposed to such conditions



alert the service provider, who will carry out a safety check.

Cleaning

Before cleaning the machine, the power button must be switched to OFF (0) and the plug must be removed from the power socket. Wait for the machine to cool down. Never immerse the machine in water! It is strictly forbidden to tamper with the internal parts of the machine. Do not clean the machine using a jet of water.

The appliance and its components must be cleaned and washed following a period of inactivity.

Using Milk (where available)

Milk must be used and stored in accordance with the instructions given on the manufacturer's original packaging.

We accept no liability for use of milk unsuitable for human consumption.

Milk must be kept cold, as high temperatures will make it turn sour - this is a natural characteristic of milk. For this reason, the Cappuccinatore must be cleaned after each use, as described in the manual.

For thorough cleaning, the Cappuccinatore can be detached and disassembled, and its parts can be put into a dishwasher (not of professional type).

Washing component parts in the dishwasher may cause Cappuccinatore surfaces to tarnish or the graphics to fade, especially if harsh detergents are used.

This circumstance is normal and does not af-

fect the correct operation of the milk brewing system.

Storing the Machine

If the machine is to remain inactive for a long time, turn it off and unplug it. Store the machine in a dry place, out of the reach of children. Keep it protected from dust and dirt.

Repairs / Maintenance

In case of breakdown, defect or a suspected fault resulting from a fall, immediately remove the plug from the power socket and alert the service provider or specialised technician.

Never attempt to operate the machine if it is faulty. Only the service provider and/or technician may service or repair the machine.

CONTENTS

1 GENERAL INFORMATION	7	9 INSTALLATION	22
1.1 Intended Use of the Machine	7	9.1 Safety Instructions	22
1.2 How to Read the Manual.....	7	9.2 Stop Functions	23
1.3 How to Use these Operating Instructions	7	9.3 List of Accessories	23
1.4 Machine Identification.....	7	9.4 Assembly-Siting.....	24
1.5 Technical Specifications	8	9.5 Disposal of Packaging	24
1.6 Residual Risks	8	9.6 Filling the Water Tank.....	24
2 MACHINE COMPONENTS	8	9.7 Filling the Coffee Bean Hopper.....	24
2.1 Control Panel Description	9	9.8 Electrical Connection.....	25
3 USING THE MACHINE	9	9.9 Turning on/off the Machine	25
3.1 Filling the Water Tank.....	9	9.10 First Use - Use After a Long Period of Inactivity	25
3.2 Filling the Coffee Bean Hopper.....	9	9.11 Measuring and Adjusting Water Hardness	26
3.3 Turning on the Machine	10	9.12 "INTENZA+" Water Filter	26
3.4 Warm-up and Rinsing	10	9.13 Adjusting the Coffee Grinder	28
3.5 Rinse/Self-Cleaning Cycle.....	10	10 MACHINE PROGRAMMING	29
3.6 Eco-friendly: Stand-by	11	10.1 Accessing the Programming Mode.....	29
3.7 Adjusting the Dispensing Spout.....	11	10.2 Programming Controls.....	30
3.8 Adjusting the Aroma (Coffee Strength)	11	10.3 Programming Menu.....	30
3.9 Coffee Brewing	11	10.4 Setting the PASSWORD	32
3.10 Adjusting the Coffee Length	12	10.5 Setting Credits	33
3.11 Emptying the Coffee Grounds Drawer	12	11 CLEANING AND MAINTENANCE	34
3.12 Dispensing Steam / Preparing a Cappuccino	13	11.1 Cleaning Intervals	34
3.13 Dispensing Hot Water.....	14	11.2 Brew Group Lubrication	34
4 USING THE MACHINE WITH CREDITS	14	11.3 Descaling	35
5 USER PROGRAMMING	14	12 MACHINE DISPOSAL	38
5.1 Machine Functions.....	15	13 TROUBLESHOOTING	38
5.2 Programming Machine Functions	15		
6 CLEANING AND MAINTENANCE	16		
6.1 Cleaning the Pannarello.....	16		
6.2 Cleaning the Coffee Grounds Drawer.....	17		
6.3 Cleaning the Drip Tray	17		
6.4 Brew Group - Weekly Cleaning.....	17		
7 MACHINE WARNINGS	20		
8 HANDLING AND STORAGE	22		
8.1 Handling.....	22		
8.2 Storage	22		



1 GENERAL INFORMATION

1.1 Intended Use of the Machine

This machine automatically brews:

- Coffee and espresso coffee using coffee beans;
- Hot beverages using hot water and/or steam dispensed via the dispensing spout;
- Milk-based beverages using the supplied Pannarello and/or Cappuccinatore (where required).

The elegant machine housing has been designed for use in small offices, businesses and institutions.



Important.

Misuse voids all forms of warranty, releasing the Manufacturer from any responsibility for damage to property or personal injury.

The following are considered misuse:

- any use other than the intended use and/or employing methods other than those described in this manual;
- any operation on the machine in breach of the instructions provided in this manual;
- any use following tampering with machine components and/or alteration of its safety mechanisms;
- use of the machine outdoors.

In such cases the user shall bear the costs of repair.

1.2 How to Read the Manual

Various kinds of warning signs are used in this manual to highlight the different hazard or competence levels.



The warning triangle indicates important instructions for the safety of the machine's users.

Carefully follow these instructions to avoid serious injury!

Various warning signs are used in this manual to indicate the competences of each user.

User:



A person who uses the machine to brew beverages and who can clean the machine, where instructed to do so in the manual. Users are NOT allowed to perform operations which are the competence of the Service Provider/Supply Operator or Technician. On detecting machine failures and/or faults, users should contact the Service Provider only.

Service Provider/Supply Operator:



Company or person responsible for normal machine installation, start-up and suspension of service. On detecting machine failures, the Service Provider should request the assistance of the maintenance technician.

Technician:



Personnel qualified to perform unscheduled maintenance and to service the machine.

Technicians may carry out all operations described in this manual without requiring explicit authorization.



This warning sign is used to highlight information that is particularly important in order to guarantee the best performance of the machine.

1.3 How to Use these Operating Instructions



This manual constitutes an integral part of the machine and should be read carefully. It contains information regarding installation, maintenance and proper use of the machine.

Always refer to this manual before any operation.

Keep these operating instructions in a safe place and make them available to anyone who may use the coffee machine. If this manual is lost or damaged, a copy should be requested from the service provider immediately. For further information or if you experience problems not completely or sufficiently covered in these instructions, please contact the service provider.

1.4 Machine Identification

The machine is identified by the model name and serial number shown on the special plate.

The plate contains the following information:

- Name of the Manufacturer
- CE marking
- Machine model
- Serial number
- Year of manufacture
- Some technical specifications:
 - Power supply voltage (V);
 - Power supply frequency (Hz);
 - Electrical power consumption (W).



Note: When contacting the Service Provider, always refer to this plate, and to the machine's specific data shown on it.

1.5 Technical Specifications

Technical Specifications
Power Supply and Nominal Voltage-Power Rating See plate attached to the back of the appliance
Machine Housing Material Metal - Thermoplastic Material
Size (w x h x d) 215 x 370 x 429 (mm)
Weight approx. 8 kg
Power Cord Length 1.2 m
Water Tank Capacity 2.5 litres
Coffee Grounds Drawer Capacity 15 grounds
Control Panel On the front
A-weighted Sound Pressure Level Less than 70 dB
Pump Pressure Max. 1.5 MPa (15.0 bar)
Operating Conditions Minimum temperature: above 10°C Maximum temperature: below 40°C Maximum humidity: below 95%
Safety Devices Boiler pressure safety valve Safety thermostat

Subject to engineering and manufacturing changes due to technological improvements.

1.6 Residual Risks

The dispensing outlet has no guards to prevent accidental hand contact with coffee, hot beverages and/or steam.

2 MACHINE COMPONENTS

i Note: The "key to components" includes all machine models; check which one matches your machine. Certain functions may not be available.

- 1 Water tank lid
- 2 Water tank
- 3 Control panel
- 4 Full drip tray float
- 5 Cup holder grill
- 6 Drip tray
- 7 Coffee bean hopper lid
- 8 Coffee bean hopper
- 9 Coffee grounds drawer
- 10 Brew Group
- 11 Coffee residues drawer
- 12 Service door
- 13 Steam wand + rubber grip for Pannarello
- 14 Coffee dispensing spout
- 15 Pannarello
- 16 Chassis plug
- 17 ON/OFF button
- 18 "Espresso" button
- 19 "Brew" button
- 20 "Aroma" button
- 21 "Stand-by" button
- 22 "Steam" button
- 23 "Hot Water" button
- 24 "MENU" button
- 25 Display

2.1 Control Panel Description

i Note: All possible controls are described here. Refer to the following sections for the operating modes.

Reference - Description
<p>18 "ESPRESSO" button When this button is pressed an espresso coffee is brewed.</p>
<p>19 "BREW" button When this button is pressed a cup of coffee is brewed.</p>
<p>20 "Aroma" button When this button is pressed the Aroma of the coffee to be brewed can be selected.</p>
<p>21 "Stand-by" button When this button is pressed, the machine Stand-by mode is activated.</p>
<p>22 "Steam" button When this button is pressed, the machine starts dispensing steam.</p>
<p>23 "Hot Water" button When this button is pressed hot water is dispensed.</p>
<p>24 "MENU" button When this button is pressed the user menu can be accessed, which allows programming of certain parameters relating to machine operation.</p>
<p>25 LCD Display Displays the machine status and alarm signals, and guides the user through the steps required to operate the machine.</p>

3 USING THE MACHINE

Before using the machine, check that the water tank and the coffee bean hopper are filled and that the machine is properly clean.

3.1 Filling the Water Tank

Before turning on the machine, the water tank should be filled with fresh drinking water.

Warning! Before using the machine for the first time, wash the water tank carefully. Fill the water tank with fresh drinking water only. Hot or carbonated water, as well as other liquids, will damage the machine.

- 1 (Fig.04, page 3)** Remove the lid from the water tank.
- 2 (Fig.05, page 3)** Remove the tank; lift it using the inside handle.
- 3 (Fig.06, page 3)** Rinse it and fill with fresh water, making sure that the (MAX) level indicated in the tank is not exceeded.
- 4** Insert the water tank back into its seat and refit the lid.

3.2 Filling the Coffee Bean Hopper

Before turning on the machine, check that the hopper contains a sufficient quantity of coffee beans.

Warning! Only coffee beans must be put into the coffee bean hopper. Ground coffee, instant coffee or any other object may damage the machine.

- 1 (Fig.03, page 3)** Remove the coffee bean hopper lid.

i Note: The hopper may feature a different safety system according to the regulations applicable in the country of use of the machine.

- 2** Slowly pour the coffee beans into the hopper.

i If the water tank is not inserted, check that no coffee beans fall into the tank compartment. If this happens, remove them to avoid any malfunctions.

- 3** Refit the coffee bean hopper lid.

3.3 Turning on the Machine

 **Warning! Connection to the power supply should be carried out exclusively by the service provider!**

Before turning on the machine, ensure that the plug is correctly inserted in the power socket.

1 To turn on the machine, move the power button on the back of the machine to "I" (Fig.02, page 3).

2 After carrying out a check cycle, the machine goes into Stand-by mode and the "⏻" button (21) blinks.

3 To turn on the machine simply press the "⏻" button (21).

i **Note: Once the warm-up is complete, the machine performs a rinse cycle of the internal circuits. A small amount of water is dispensed during this process. Wait for this cycle to be completed.**

3.4 Warm-up and Rinsing

1 Upon start-up, the machine activates the warm-up phase. Wait until it is completed.

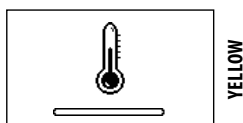

i **Note: The progress bar indicates that the machine is warming up the system.**

2 Once the warm-up is complete, the machine performs a rinse cycle of the internal circuits.



i **Note: The progress bar indicates that the machine is performing the rinse cycle of the system.**

3 A small amount of water is dispensed from the coffee dispensing spout. Wait for the cycle to end.

i **Note: The cycle can be stopped by pressing the "☺" button (18).**

4 When completed, the machine is ready for use.

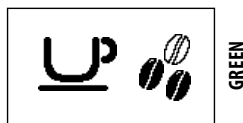

i **Note: If the machine is being used for the first time or after a long period of inactivity, contact the Service Provider to start it up.**

3.5 Rinse/Self-Cleaning Cycle

This cycle allows the internal coffee circuits to be rinsed with fresh water. The cycle is carried out:

- At machine start-up (with cold boiler);
- After priming the circuit (with cold boiler);
- During the Stand-by preparation phase (if at least one coffee-based product has been brewed);
- When turning off the machine, after pressing the "⏻" button (21) (if at least one coffee-based product has been brewed).

A small amount of water will be dispensed to rinse and heat all the machine parts; in this phase this icon is displayed.



Wait for the cycle to finish automatically. The dispensing process can be stopped by pressing the "☺" button (18).

3.6 Eco-friendly: Stand-by

The machine is designed for energy saving. The machine automatically turns off after 30 minutes of inactivity.



Note:

- During the turning off phase, the machine will perform a rinse cycle if a coffee product has been brewed.
- Time can be programmed according to your needs (see instructions in chapter 5).

To turn the machine on again, simply press a button on the control panel (if the power button is set to "I"). In this case the machine will go through the rinse cycle only if the boiler is cold.

3.7 Adjusting the Dispensing Spout

Most of the cups on the market can be used with this coffee machine.

The height of the dispensing spout may be adjusted to better fit the dimensions of the cups that you wish to use.

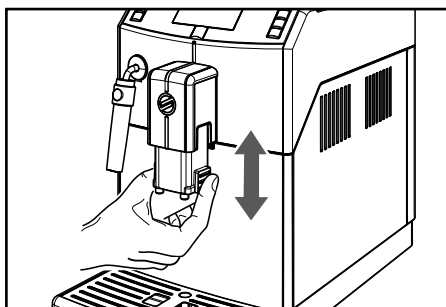

Manually move the dispensing spout up or down to adjust its height.

The recommended positions are:

- When using small cups (**Fig.07, page 3**);
- When using large cups and/or latte macchiato cups (**Fig.09, page 3**).

Two cups can be placed under the dispensing spout to brew two cups of coffee at the same time (**Fig.05, page 3**).

3.8 Adjusting the Aroma (Coffee Strength)

Choose your favourite coffee blend and adjust the amount of coffee to be ground according to your personal taste. You can also select the pre-ground coffee function.



Note: Selection must be made prior to selecting coffee.

Three choices are possible by pressing the (20) "☉" button. Each time the button is pressed, the aroma changes by one degree, according to the selected amount:

- ☉☉☉ = mild aroma
- ☉☉☉☉ = medium aroma
- ☉☉☉☉☉ = strong aroma

3.9 Coffee Brewing

To brew coffee, press and release:

1 the "☉" button (18) to brew an espresso coffee; the following icon is displayed;

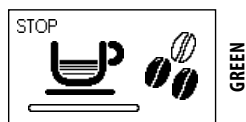

or

the "☉☉" button (19) to brew a coffee; the following icon is displayed;



Then the brewing cycle starts:

Press the desired button once to brew 1 cup of coffee.

Press the desired button twice consecutively to brew 2 cups of coffee.



Note: To brew 2 cups of coffee, the machine automatically grinds and doses the correct amount of coffee. Brewing two coffees requires two grinding cycles and two brewing cycles, carried out automatically by the

machine; the display shows the 2 cups icon.

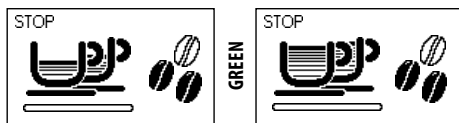

2 Once the prebrewing cycle is complete, coffee begins to come out of the dispensing spout.

3 Coffee brewing stops automatically when the set level is reached. However, the coffee brewing process can be stopped manually by pressing the "☺" button (18).

i **Note:** The machine is set to brew a true Italian espresso coffee. This feature may slightly lengthen the brewing time, allowing the intense coffee flavour to develop fully.

3.10 Adjusting the Coffee Length

The machine allows the amount of brewed coffee to be adjusted according to taste and cup size.

Each time the "☺" button (18) or the "☺" button (19) is pressed, the machine brews a pre-set amount of coffee. Each button may be individually programmed for a specific brew setting. The following procedure describes the "☺" button (18) programming.

1 Place a cup under the coffee dispensing spout (Fig.07, page 3).

2 Press and hold the "☺" button (18) until the "MEMO" icon appears on the display, then release the button. The machine is now in programming mode.



The machine starts brewing coffee.



3 When the "STOP" icon is displayed, press the "☺" button (18) as soon as the desired amount of coffee is reached.

The "☺" button (18) has now been programmed. Each time it is pressed, the machine will brew the same amount of espresso coffee that has just been programmed.

i **Note:** To program the "☺" button (19), the same steps should be followed.

You should always use the "☺" button (18) to stop brewing coffee when the desired amount of coffee is reached even when you are programming the "☺" button (19).

3.11 Emptying the Coffee Grounds Drawer

i **Note:** This operation must be performed with the machine turned on.

The machine will indicate when the coffee grounds drawer has reached its maximum capacity.

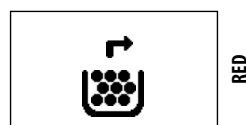

In this case the machine does not allow coffee to be brewed. In order to continue to brew coffee, the coffee grounds drawer must be emptied of used coffee.

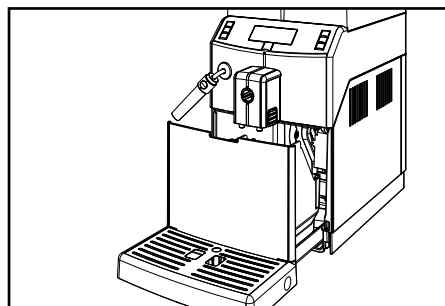

1 Make sure that the dispensing spout is positioned upwards (Fig.09, page 3).

2 Turn the Pannarello to the left.

3 Remove the drip tray.

4 (Fig.13, page 3) Remove the coffee grounds drawer and empty out the coffee grounds in a suitable container.

i Note: It is advisable to also empty the drip tray (see section 6.3).

Only when the display shows the following icons in sequence:



RED

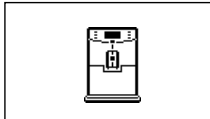

RED

may the coffee grounds drawer be inserted into the machine. After inserting the drawer, the display shows the icon:

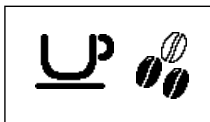

GREEN

The machine is now ready to brew coffee.

3.12 Dispensing Steam / Preparing a Cappuccino

The machine can dispense steam quickly and easily with the touch of a button.

⚠ **Danger of scalding!** Dispensing may be preceded by small jets of hot water. The Pannarello may reach high temperatures. Never touch it with bare hands. Use the appropriate protective handle only.

i **Important Note:** Immediately after using steam, clean the Pannarello as described in section 6.1.

1 Fill 1/3 of a container with cold milk.

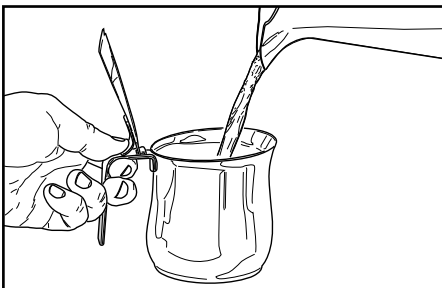

i Note: To make a good quality cappuccino, use cold milk (~5°C / 41°F) with a protein content of at least 3%. Whole milk or skimmed milk may be used depending on individual taste.

i Note: When you plan to dispense steam right after switching on the machine or after brewing a coffee, some water still present in the circuit may need to be dispensed first. To do this, press the "☞" button (22) to dispense steam for a few seconds. Thereafter press the "☞" button (18) to stop dispensing. Continue with step 2.

2 Place the Pannarello inside the container with the milk (Fig.10, page 3). Press the "☞" button (22).

2 The machine needs time to preheat.

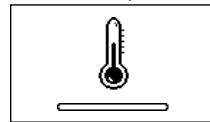

YELLOW

3 After preheating, the machine starts dispensing steam.



GREEN

4 In this phase, froth the milk as desired or heat the beverage to the required temperature.

i Note: Froth the milk by gently swirling the container and moving it up and down.

5 To conclude the steam dispensing process, press the "☞" button (18).

i Note: After having pressed the "☞" button (18) it will take a few seconds before the machine stops dispensing steam completely.

3.13 Dispensing Hot Water

! Danger of burning! Dispensing may be preceded by small jets of hot water. The Pannarello may reach high temperatures: Do not touch it with bare hands. Use the appropriate protective handle only.

- 1 Place a container under the Pannarello (Fig.10, page 3).
- 2 Press the "☕" button (23) to start dispensing hot water.
- 3 The machine needs time to preheat.

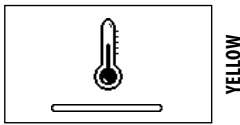

YELLOW

- 4 After preheating, the machine starts dispensing hot water.



GREEN

- 5 To stop the hot water dispensing process, press the "☕" button (18). After dispensing, remove the container with hot water.

4 USING THE MACHINE WITH CREDITS

i Note: This option can be enabled or disabled by the service provider.

The machine is designed to manage coffee brewing by means of a credit system. The number of coffee cups brewed is limited to the number of credits granted by the service provider. When no credits remain, no more cups of coffee can be brewed.

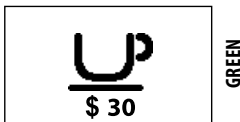

GREEN

When fewer than 31 credits are left in the machine, the icon "\$" is displayed. In this case, contact the service provider to restore the credits.

When no credits remain, the following icon is displayed and the machine stops brewing coffee.

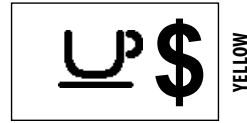

YELLOW

i Note: The dispensing of hot water and steam is not subject to credit; it can always be performed provided that there is water in the tank.

Each service provider decides independently how to manage the granting and recharging of credits to allow the machine to be used.

5 USER PROGRAMMING

Certain machine parameters can be programmed to improve the brewing of a desired product, and to better manage machine operation.

- 1 Press the "☕" button (24) to access the machine's main menu.

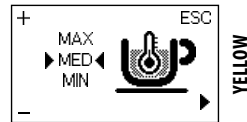

YELLOW

The first screen appears, which allows the coffee brewing temperature to be changed.

The buttons change their function when in programming mode:

- the "☕" button (18) = (+) increases the value
- the "☕" button (20) = (-) decreases the value
- the "☕" button (24) = (▶ or OK) selects or confirms
- the "☕" button (22) = (ESC) exits or cancels

5.1 Machine Functions

The following functions can be programmed:

Coffee Temperature

This function allows you to adjust the coffee brewing temperature.

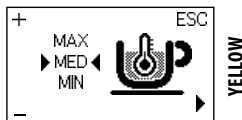

Timer (stand-by)

This function adjusts the time taken for the machine to go into stand-by mode after the last brewing.

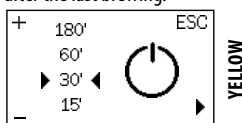

Contrast

This function allows you to adjust the contrast of the display to better view the messages.

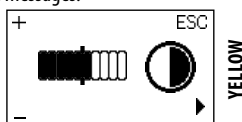

5.2 Programming Machine Functions

In this example, how to program the display contrast is shown. Proceed in the same way to program the other functions.

The programming menu can only be accessed when the machine is on and shows this display.

1 Press the “☰” button (24) to access programming mode.

2 The main screen will be displayed.

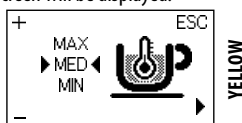

3 Press the “☰” button (24) to scroll the pages until the display contrast function is displayed.

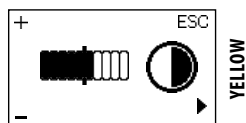

4 Press the “☰” (18) and “☉” (20) buttons to increase or decrease the value of the function.

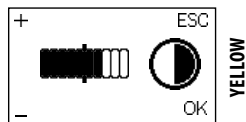

5 When the display value is changed, the “OK” message appears. Press the “☰” button (24) to confirm the change.

6 Press the “☞” button (22) to exit the programming mode.

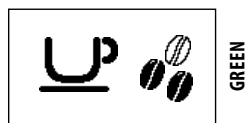

i **Note:** The machine will automatically exit the programming mode if you do not press any button for 3 minutes. The values that have been changed but not confirmed won't be saved.

6 CLEANING AND MAINTENANCE

As some of the parts of the appliance come in contact with water and coffee during normal use, it is important to clean the appliance regularly.

Neglecting to regularly clean the appliance will ultimately cause it to stop working properly, and in this case repair is not covered under warranty.

Warning. Before undertaking any maintenance and/or cleaning operation, turn off the machine, unplug it and wait for it to cool down.

Non-removable parts and the machine itself must be cleaned, when not otherwise specified, using only cold or lukewarm water, with a non-abrasive sponge and a damp cloth.

- Cleaning can only be carried out when the machine is cold and unplugged.
- Use a soft, damp cloth to clean the machine.
- Do not use direct jets of water.
- Do not immerse the machine in water or place any of its parts in a dishwasher.
- Do not use sharp objects or harsh chemical products (solvents) for cleaning.
- Do not dry the machine and/or its parts using a microwave and/or standard oven.
- All parts requiring cleaning are easily accessible, so no tools are needed.
- Periodic maintenance and cleaning will keep the machine in good working order for a longer time and ensure compliance with basic hygienic standards.

Warning. The machine and its parts should in any case be cleaned every week.

i The appliance and its parts should be cleaned and washed following a period of inactivity.

6.1 Cleaning the Pannarello

Warning. Before performing this operation, make sure that the wand is cold: **Danger of burns!**

Daily cleaning

It is important that you clean the Pannarello daily or after each use as it preserves hygiene and ensures perfect milk froth consistency.

After frothing the milk, a small quantity of hot water must be dispensed into a container.

Remove the external part of the Pannarello and wash it with lukewarm water.

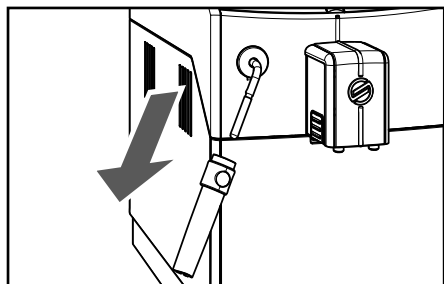

Weekly Cleaning

The weekly cleaning is more thorough, since you need to disassemble all the Pannarello components.

The following cleaning operations are required:

1 Remove the external part of the Pannarello. Wash it with lukewarm water.

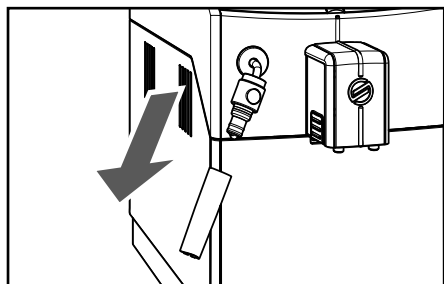

2 Remove the upper part of the Pannarello from the steam/hot water wand.

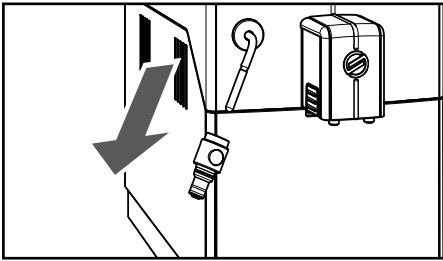

- 3 Wash the upper part of the Pannarello with fresh water.
- 4 Clean the steam/hot water wand of the Pannarello with a wet cloth to remove milk residues.
- 5 Put the upper part back into the steam/hot water wand (make sure it is completely inserted).
- 6 Reassemble the external part of the Pannarello.

6.2 Cleaning the Coffee Grounds Drawer

The coffee grounds drawer is to be emptied and cleaned whenever indicated by the machine. To carry out this operation, refer to section 3.11.

6.3 Cleaning the Drip Tray

Empty and clean the drip tray every day. Perform this operation also when the float is raised.

- 1 Remove the drip tray and the coffee grounds drawer as described in section 3.11.
- 2 Empty the drip tray and wash it.

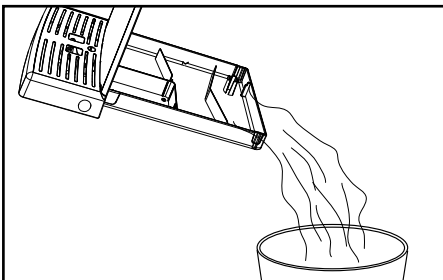

- 3 Refit the coffee grounds drawer and insert the drip tray into the machine.

6.4 Brew Group - Weekly Cleaning

The Brew Group should be cleaned whenever the coffee bean hopper is filled, or at least once a week.

- 1 Turn off the machine by switching the power button to the "0" position and remove the plug from the socket.
- 2 Remove the drip tray and the coffee grounds drawer.

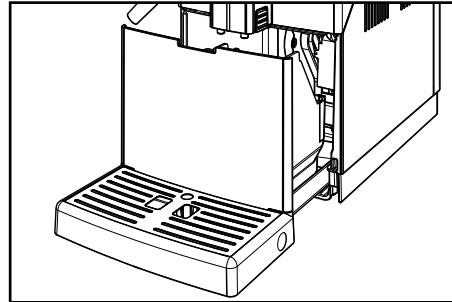

- 3 Open the service door.

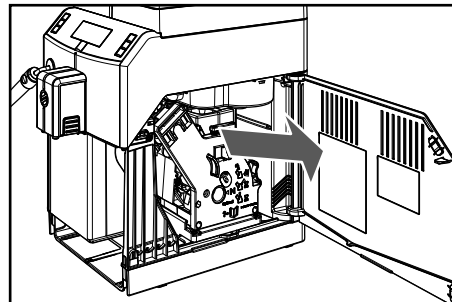

- 4 Remove the Brew Group: pull it by the handle and press the «PUSH» button. The Brew Group must be washed with lukewarm water only. Do not use detergent.

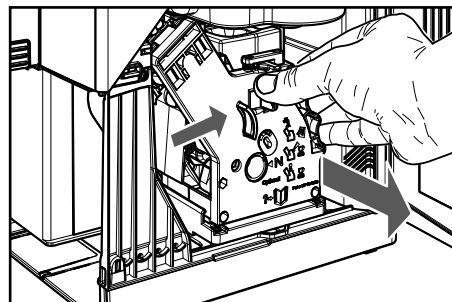

5 Wash the Brew Group with lukewarm water and carefully wash the upper filter. Before placing the Brew Group in its seat, ensure that there is no water left in the brewing chamber.

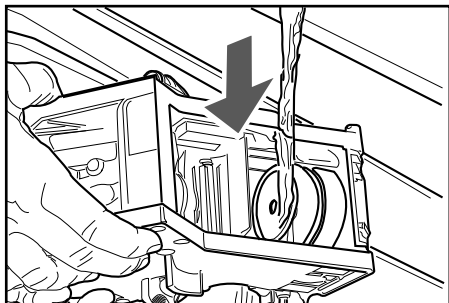

6 Remove the coffee residues drawer and wash it thoroughly.

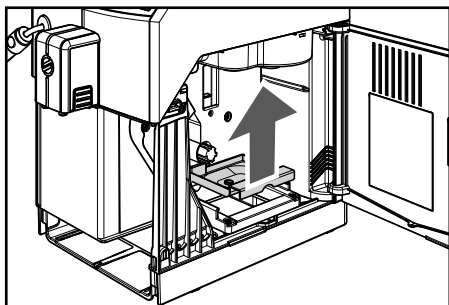

7 Clean the inside of the machine with a damp cloth.

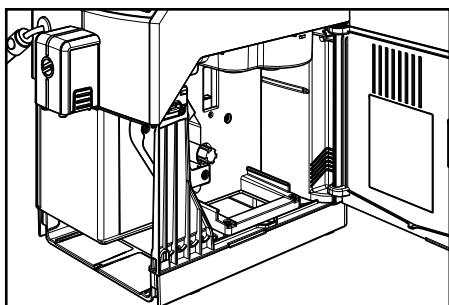

8 Insert the coffee residues drawer in its seat and ensure that it is correctly in place.

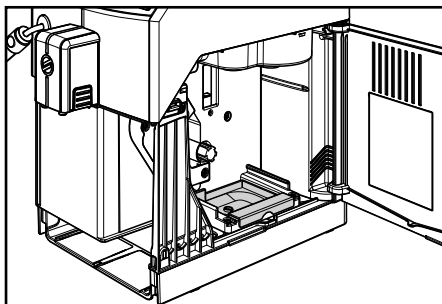

i If the coffee residues drawer is not correctly positioned, the brew group may not fit into the machine.

9 Ensure that the Brew Group is in the rest position; the two reference signs must match.

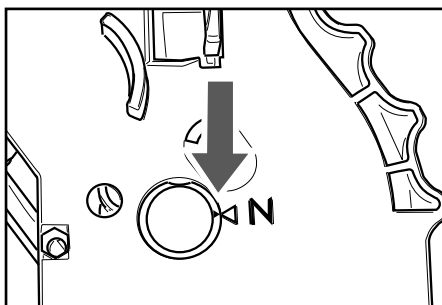

If they do not match, proceed as described in step (10).

10 Ensure that the lever is in contact with the brew group base.

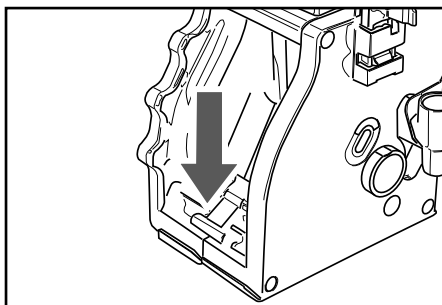

11 Make sure that the hook which locks the Brew Group is in the correct position; to check its position firmly press the "PUSH" button.

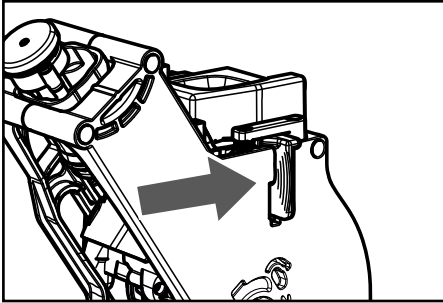



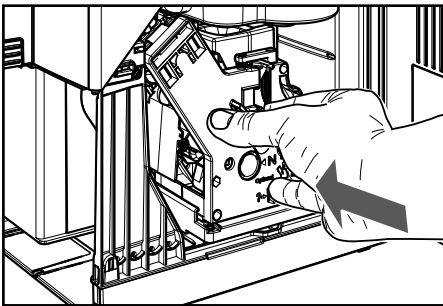





12 Insert the Brew Group into its seat again until it locks into place, WITHOUT pressing the "PUSH" button.



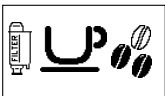

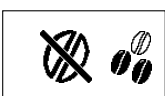

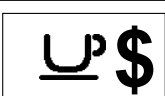
13 Insert the coffee grounds drawer and the drip tray. Close the service door.

7 MACHINE WARNINGS

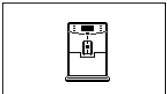
This chapter describes all the warning messages that the machine may display to the user, and the actions that can and/or must be performed by the user.

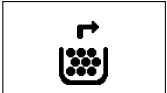
Warning Signals (Yellow Colour)	How to Reset the Message
	The machine is in warm-up phase to brew beverages or dispense hot water.
	The machine is performing the rinse phase. Wait until the machine has completed the cycle.
	The "Intenza" water filter must be replaced with a new one. Contact the service provider.
	The brew group is being reset due to machine reset.
	Refill the coffee bean hopper with coffee beans and restart the cycle.
	The machine is performing circuit priming.
	The machine is out of credits. In this case, only hot water and steam may be dispensed. To brew coffee, contact the service provider to restore the credits.
	The machine requires a descaling cycle. When this message is displayed, it is still possible to use the machine, but its correct operation might be affected. Damage caused by failure to descale the machine is not covered by warranty. Contact the service provider.

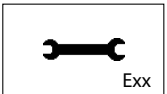
Warning Signals (Red Colour)	How to Reset the Message
 	<p>Insert the drip tray and the coffee grounds drawer into the machine and close the service door.</p>
	<p>Fill the coffee bean hopper. This icon appears for 5 seconds, from when the machine detects that it has finished the coffee to be ground. After this time the message "Refill the coffee bean hopper with coffee beans and restart the cycle" appears. (See Warning Signals (Yellow Colour)).</p>
	<p>The brew group must be inserted into the machine.</p>
	<p>Empty the coffee grounds drawer.</p>
	<p>Fill the water tank.</p>
 <p>Exx</p>	<p>Turn off the machine. Turn it back on after 30 seconds. Try this 2 or 3 times. If this signal appears again, contact the service provider and quote the code shown on the display.</p>

8 HANDLING AND STORAGE



All the operations described in chapter 8 must be performed exclusively by the service provider or a specialised technician, who shall organise all the operating steps and use only suitable means to ensure strict compliance with the safety regulations in force.

8.1 Handling

During handling and transportation, the machine must be kept in an upright position, according to the instructions printed on the packaging. Care should be taken during lifting and positioning. Do not shake the machine.



Make sure that nobody is standing in the area during load lifting and handling. In difficult conditions, assign suitable personnel to monitor all movements.

8.2 Storage

The machine should be stored in accordance with the following conditions:

- Minimum temperature: above 4°C;
- Maximum temperature: below 40°C;
- Maximum humidity: below 95%.

The machine is packed in cardboard and expanded polystyrene packaging.



Warning. Due to the total weight of the packaged product, do not stack more than three machines on top of each other. The machine should be stored in its original packaging, in a dry and/or dust-FREE place.

9 INSTALLATION



All the operations described in chapter 9 must be performed exclusively by the service provider or a specialised technician, who shall organise all the operating steps and use only suitable means to ensure strict compliance with the safety regulations in force.

9.1 Safety Instructions

- Connection to the drinking water network (for water-network supplied machines) should be made in compliance with the safety regulations in force in the country where the machine is to be used.
- The socket to which the machine is connected should be:
 - compatible with the type of plug installed on the machine;
 - suitably sized to comply with the data on the plate attached to the bottom of the appliance;
 - connected to an efficient earthing system.
- The power cord should not:
 - come into contact with any type of liquid: danger of electric shocks and/or fire;
 - be crushed and/or come into contact with sharp surfaces;
 - be used to move the machine;
 - be used if damaged;
 - be handled with damp or wet hands;
 - be wound in a coil when the machine is in use;
 - be tampered with.
- If the power cord is damaged, it must be replaced by the manufacturer or an authorised service centre, or in any case by a person with a similar qualification.
- It is forbidden to:
 - Install the machine other than as described in Chapter 9, or outdoors.
 - Install the machine in a location where water jets may be used.
 - Disable the safety features installed by the manufacturer.
 - Use the machine close to flammable and/or explosive materials.
 - Leave plastic bags, polystyrene, nails, etc., within the reach of children, as they are potential hazards.
 - Allow children to play near the machine.
 - Use spare parts other than those recommended by the manufacturer.
 - Make any technical modifications to the machine.
 - Immerse the machine in any kind of liquid.
 - Wash the machine using a jet of water.
 - Use the machine in any manner other than as described in this manual.
 - Install the machine on top of other appliances.
 - Use the machine in explosive or harsh environments, or with high concentrations of dust or oily substances suspended in the air.
 - Use the machine in an environment in which a risk of fire exists.
 - Use the machine to dispense products other than those it is designed for.

- Before cleaning the machine, ensure the plug is disconnected from the power socket; do not wash it with fuel and/or solvents of any kind.
- Do not place the machine near heating equipment (such as heaters or radiators).
- In case of fire, use carbon dioxide (CO₂) extinguishers. Do not use water or dry powder extinguishers.

9.2 Stop Functions

The machine can be stopped by means of the power button.

9.3 List of Accessories

9.3.1 List of Accessories Supplied

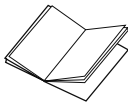

Manual: instructions on how to use the machine.



Power cord: to connect the machine to the mains.

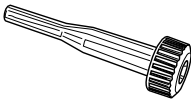

Grinder adjustment key: for coffee grinder adjustment.

9.3.2 List of Optional Accessories

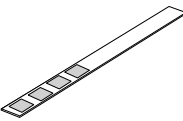

chine.

Water hardness test: quick test to determine the actual hardness of the water used to prepare beverages; this test is of fundamental importance to set the water hardness in the machine.

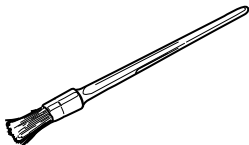

Cleaning brush: to remove the coffee grounds from the service compartment.



Lubricating oil: to lubricate the Brew Group at periodic intervals (see section 11.2).



Descaling solution: to remove limescale build-up in the water circuit caused by normal use.



"Intenza +" water filter: to remove any unpleasant flavours in the water and reduce water hardness. This will improve machine use.

9.4 Assembly-Siting

! The machine should not be installed outdoors or in environments in which jets of water or steam are used.

! The presence of magnetic fields or proximity to electrical machines which generate interference could cause the electronic controls of the machine to malfunction. At temperatures close to 0°C, internal parts containing water are at risk of freezing. Do not use the machine under these conditions.

To ensure correct and efficient performance of the appliance, comply with the following recommendations:

- room temperature: 10°C - 40°C;
- maximum humidity: 90%;
- the site should be suitably prepared for the installation of the machine;
- the surface on which the machine is installed should be level, solid and stable, with a gradient of max. 2°;
- the location should be adequately lit, ventilated and clean, and the power socket should be easily accessible.

! Access to the machine and the plug should be kept clear at all times, in order to allow users to easily reach them and to leave the area immediately if required.

The following illustration shows the required access distances:

- to the keypad on the front of the appliance;
- to the service units in the event of malfunction.

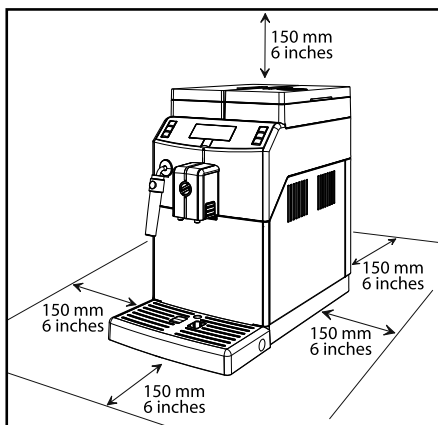

After placing the packaged product near the installation site, proceed as follows:

- ensure that the packaging has not been tampered with during transport and that the original packaging is intact and closed;
- open the packaging;
- check the condition and model of the machine;
- check the content of the accessories bag enclosed with the machine (see "9.3 List of Accessories");
- remove the machine from its original packaging;
- remove any remaining packaging from the machine;
- lift the machine and place it in the designated area.

9.5 Disposal of Packaging

After opening the outer box, it is recommended that the packaging materials are separated according to type and disposed of in accordance with the regulations in force in the country of use.



We recommend keeping the outer box for future transfers or transportation.

9.6 Filling the Water Tank

Before turning on the machine, the water tank should be filled with fresh drinking water.



Warning! Before using the machine for the first time, wash the water tank carefully. Fill the water tank with fresh drinking water only. Hot or carbonated water, as well as other liquids, will damage the machine.

Refer to section 3.1. to carry out the procedure correctly.

9.7 Filling the Coffee Bean Hopper

Before turning on the machine, check that the hopper contains a sufficient quantity of coffee beans.



Warning! Only coffee beans must be put into the coffee bean hopper. Ground coffee, instant coffee or any other object may damage the machine.

Refer to section 3.2. to carry out the procedure correctly.

9.8 Electrical Connection

This operation must only be performed by specialised technical personnel or by the service provider.

The machine is designed to work with single-phase voltage matching the rating indicated on the identification plate (section 1.4 "Machine Identification").

Before plugging in the machine, make sure that the power button is switched to "0".

The Service Provider makes and is responsible for the electrical connection of the machine.

The machine should be connected to the mains using the plug installed on the power cord, in accordance with:

- The Laws and Regulations in force at the place and time of installation;
- The information shown on the technical specifications plate on the side of the machine.

Warning: The electric socket which the appliance is connected to should be easily accessible by the user, in order to allow it to be easily disconnected from the mains when necessary.

It is forbidden to:

- Use extensions of any kind.
- Replace the original plug.
- Use adapters.

9.9 Turning on/off the Machine

The machine can be turned on/off by pressing the button located to the rear of the machine (Fig.02, page 3).

9.10 First Use - Use After a Long Period of Inactivity

For a perfect Espresso: Rinse the coffee circuit if using the machine for the first time or after a long period of inactivity.

These simple operations will allow you to always brew excellent coffee. They have to be performed:

- At first start-up;
- When the machine remains inactive for a long time (more than 2 weeks).

9.10.1 At First Start-up

To turn on the machine simply press the "⏻" button (21). The control panel indicates that the circuit must be primed.

- Place a large container under the dispensing spout (Fig.11, page 3).



The machine automatically starts circuit priming. It will then carry out the warm-up and rinse cycle as described in section 3.4.

9.10.2 After a Period of Inactivity

- Empty the water tank, wash and rinse it and fill it with fresh water (see section 9.6).

- Place a large container under the dispensing spout (Fig.11, page 3).

- Press the "☕" button (19) to start the brewing procedure.

- The machine will brew coffee through the dispensing spout (Fig.11, page 3); wait until the procedure is complete and empty the container.

- Repeat the operations from step 2 to step 4 three times, then continue with step 6.

- Place a container under the steam/hot water wand (Fig.10, page 3).

- Press the "☕" button (23) to start dispensing HOT WATER. Dispense water until the no water icon is displayed.



- When the hot water dispensing procedure is complete, empty the container.

- 9 Fill the water tank again up to the MAX level.

The machine is now ready for use.

9.11 Measuring and Adjusting Water Hardness

Measuring water hardness is very important in order to correctly manage the "INTENZA+" filter and the frequency with which the machine must be descaled.

- 1 Immerse the water hardness test strip in water for 1 second.

i **Note: The test strip is only valid for one measurement.**

- 2 Check how many squares change colour and refer to the table.

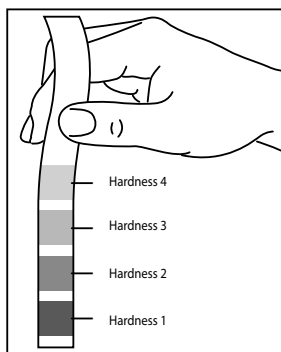

- 3 The numbers correspond to the settings indicated in the following machine adjustments.

HARDNESS 4 (hard)
 HARDNESS 3 (medium)
 HARDNESS 2 (soft)
 HARDNESS 1 (very soft)

- 4 Switch to programming mode as described in section 10.1.

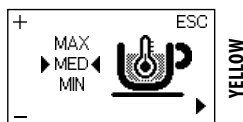

- 5 Press the "☰" button (24) until the following menu is displayed:

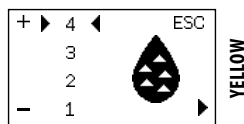

i **Note: The machine is supplied with standard adjustments, suitable for most uses.**

- 6 Press:
 the "MEMO" button (18) to increase the value
 or
 the "●" button (20) to decrease the value.

- 7 Press the "☰" button (24) to confirm the selected change.

After adjusting water hardness, install the filter (Intenza+), as described in the following section. Then, exit programming mode as described in section 10.2.

9.12 "INTENZA+" Water Filter

Water is a key element for a good espresso coffee. It should therefore always be filtered in a professional manner. That is why all Saeco machines can be equipped with the INTENZA+ filter. This filter is easy to use and its sophisticated technology is effective in preventing limescale build-up. This way, water will always be perfect and will give a much more intense aroma to your espresso coffee.

! **The descaling filter should be replaced whenever indicated by the machine. Before descaling, remove the anti-scale filter from the water tank.**

i **Measuring water hardness is very important in order to correctly manage the "INTENZA+" water filter and the frequency with which the machine must be descaled.**

- 1 Remove the "INTENZA+" water filter from its packaging. The filter should be set according to the measurements performed to set water hardness.

Use the water hardness test strip provided with the machine. Set the "Intenza Aroma System" as specified on the filter packaging (see section 9.11).

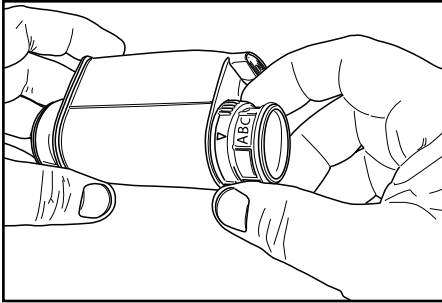

- A = Soft water
- B = Hard water (standard)
- C = Very hard water

2 Immerse the "INTENZA+" water filter vertically in cold water (with its opening positioned upwards) and delicately press its sides so as to let the air bubbles out.

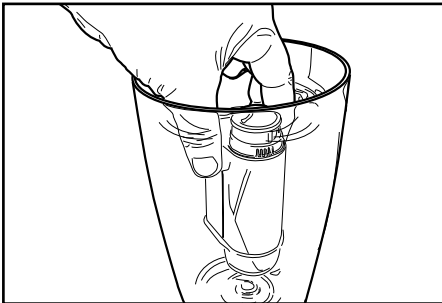

3 Remove the tank from the machine and empty it. Remove the small white filter from the tank and store it in a dry place sheltered from dust.

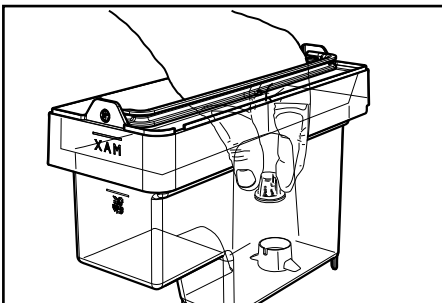

4 Put the filter into the empty tank. Press it to its limit stop.

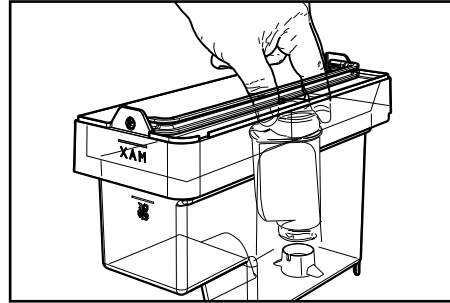

5 Fill the tank with fresh drinking water and reinsert it into the machine.

6 Switch to programming mode as described in section 10.1.

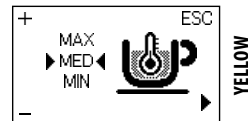

7 Press the "☰" button (24) until the following menu is displayed:

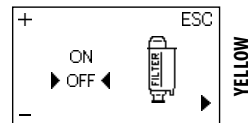

8 Press the "☺" button (18) to select "ON" and press the "☰" button (24) to confirm.

9 Exit the programming menu and dispense about half the water tank content to activate the filter.

10 Fill the water tank again up to the MAX level with fresh drinking water.

9.12.1 Replacing the "Intenza+" Water Filter

If the filter is already installed and the machine indicates that it must be replaced, proceed as previously described.

When accessing the programming page, the "RESET" option will also be available.

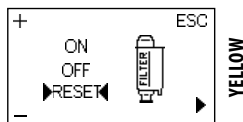

Select this option to reset the alarm.

9.12.2 Removing the "Intenza+" Water Filter

If the filter is installed in the machine and you want to remove it, access the programming page and select the "OFF" option.

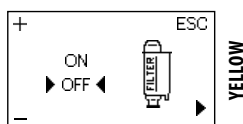

i Note: It is important to reinstall the small white filter that was previously removed while installing the "INTENZA+" water filter.

9.13 Adjusting the Coffee Grinder

! Warning! Do not pour ground and/or instant coffee into the coffee bean hopper. Do not put any material other than coffee beans into the hopper. The coffee grinder contains moving parts that may be dangerous. Do not insert fingers and/or other objects. Turn off the machine by pressing the ON/OFF button and remove the plug from the socket before carrying out any type of operation inside the coffee bean hopper.

! Only turn the grinder adjustment knob inside the coffee bean hopper when the ceramic coffee grinder is in use.

This adjustment can be carried out by pressing and turning the grinder adjustment knob inside the coffee bean hopper, using the coffee grinder adjustment key provided with the machine.

1 Press and turn the grinder adjustment knob one notch at a time. You will taste the difference after brewing 2 to 3 cups of coffee.

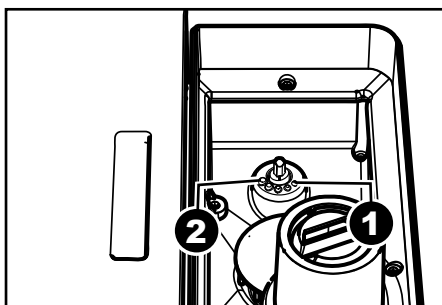
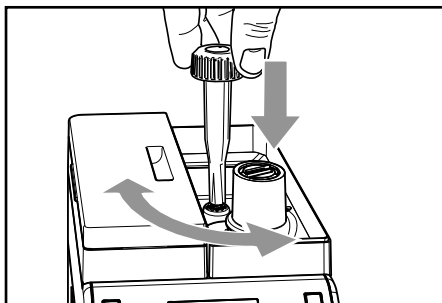

The reference marks indicate the grind setting. You can set different degrees of grind with the following references:

- 1 - Fine Grind
- 2 - Coarse Grind

10 MACHINE PROGRAMMING



All the operations described in chapter 10 must be performed exclusively by the service provider or a specialised technician, who shall organise all the operating steps and use only suitable means to ensure strict compliance with the safety regulations in force.

The specialised technician or the service provider can change some of the machine operating parameters to suit the needs of the users.

10.1 Accessing the Programming Mode

Proceed as follows to access programming mode.

- 1 With the machine turned on, press and hold the "☞" button (22) and the "☺" button (23) at the same time for 5 seconds.

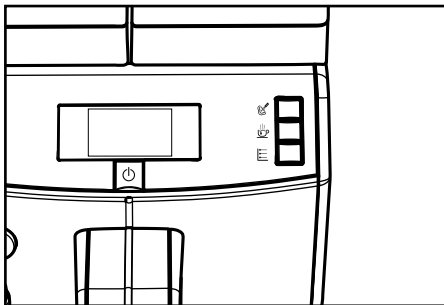

- 2 The following screen is displayed:

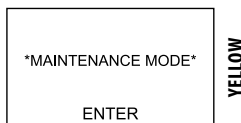

- 3 Press the "☺" button (21) to access programming mode.

i Note: The above mentioned procedure can only be used to access the programming menu when the machine has reached operating temperature. To execute certain programmes (e.g. DESCALING), the machine will manage the procedure automatically and warm up according to the manufacturer's settings.

i Note: After 3 minutes of inactivity, the machine will exit programming mode and return to standard operating mode.



The menus should be PASSWORD-protected.



The PASSWORD will not be requested if set on the default value (0000). It should be changed upon 1st use to prevent unauthorised access. After this change, it should be entered again at each access, every time the display shows:

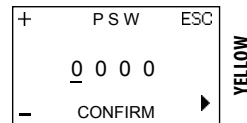





Refer to section 10.4 on how to set the PASSWORD.

To enter the password:

- 1 Press the "☺" (18) or "☹" (20) button to set the desired number.
- 2 Press the "☰" button (24) to move on to the next number (when it gets to the end it will start again from the beginning).
- 3 Repeat steps 1 and 2 until the set password has been entered.
- 4 Press the "☺" button (21) to confirm and to access programming mode.

10.2 Programming Controls

When the machine menus are accessed, the buttons on the keypad take on new functions.

 "change" button (18)	This button allows the parameters to be changed when they are displayed.
 "change" button (20)	This button allows the parameters to be changed when they are displayed.
 button (24) (Scroll parameters / OK)	This button allows the user to: 1 scroll through the menu pages; 2 confirm the parameter/value after changing it.
 "ESC" button (22)	This button allows the user to exit without changing the edited or selected parameter. Note: Press it repeatedly to exit programming mode.

10.3 Programming Menu

This menu manages certain machine operation parameters.

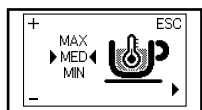

Coffee temperature

This function adjusts the coffee brewing temperature.

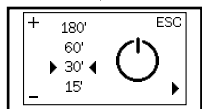

Timer (stand-by)

This function adjusts the time taken for the machine to go into stand-by mode after the last brewing.

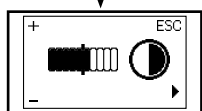

Contrast

This function allows you to adjust the contrast of the display to better view the messages.

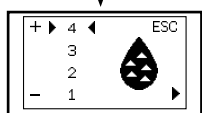

Water hardness

This function adjusts the water hardness setting according to the area where you live.

1 = very soft water

2 = soft water

3 = hard water

4 = very hard water

For more details please see the "Measuring and Adjusting Water Hardness" chapter.

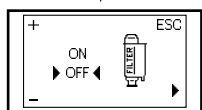

"INTENZA+" Water Filter

This function manages the "INTENZA+" water filter.

For more details, see the chapter about filter handling.



Descaling cycle

This function activates the descaling cycle.



Credit management

This function activates credit management.

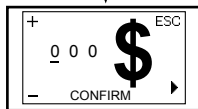

Credit charging

This function activates credit charging.

Note: This function is visible only if the "Credit management" function is set to "YES".

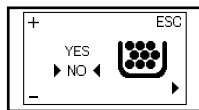

Coffee grounds drawer full alarm

This function enables/disables the alarm which warns the user that the coffee grounds drawer needs to be emptied.

Note: Disabling this alarm may cause machine malfunctions, since the coffee grounds may block the Brew Group.

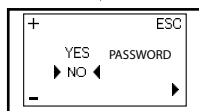

Password

This function activates the password used to access machine programming mode.

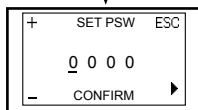

Password setting

This function changes the password used to access machine programming mode.

Note: This function is only displayed if the "Password" function is set to "YES".

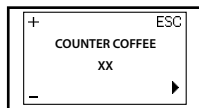

Coffee counters

This function allows you to check how many coffee cups have been brewed; the number is shown above the letters (XX). The number cannot be reset.

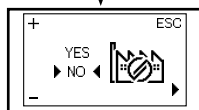

Factory settings

This function resets the factory parameters, where a malfunction occurs.

10.4 Setting the PASSWORD

The PASSWORD must be set by the service provider in order to prevent access by unauthorised personnel who could change the machine settings and cause malfunctions.

To set the PASSWORD, proceed as follows:

- 1 Switch to programming mode as described in section 10.1.

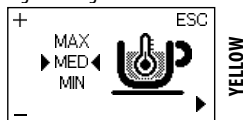

- 2 Press the "☰" button (24) until the following menu is displayed:

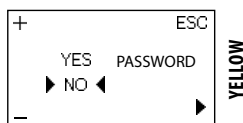

- 3 Press the "MEMO" button (18) or the "⓪" button (20) to select "YES".

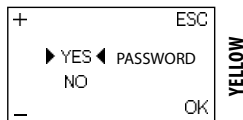

- 4 Press the "☰" button (24) to confirm.

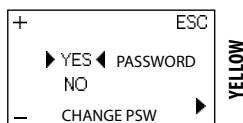

- 5 The option "CHANGE PSW" will be displayed, which will allow the password to be set.

- 6 Press the "⓪" button (21) to confirm and to set the password.

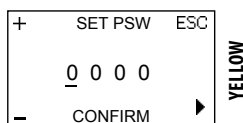

To enter the password:

- 7 Press the "MEMO" (18) or "⓪" (20) button to set the desired number.

- 8 Press the "☰" button (24) to move on to the next number (when it gets to the end it will start again from the beginning).

- 9 Repeat steps 7 and 8 until the set password has been entered.

- 10 Press the "⓪" button (21) to confirm the password and to exit the menu.

i Note: You can exit the change menu at any time without saving the setting by pressing the "⓪" button (22).

i Note: If "NO" is selected from the "PASSWORD" menu, the saved password will be cancelled.

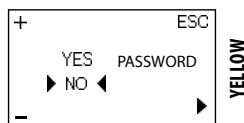

10.5 Setting Credits

Credits can be set to allow coffee to be brewed under the strict control of the service provider.

To set the credits, proceed as follows:

- 1 Switch to programming mode as described in section 10.1.

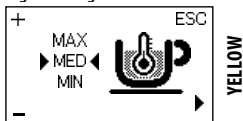

- 2 Press the "☰" button (24) until the following menu is displayed:

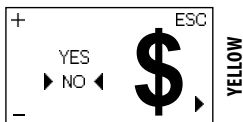

- 3 Press the "MEMO" button (18) or the "☉" button (20) to select "YES".

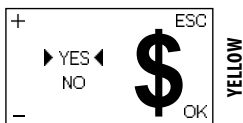

- 4 Press the "☰" button (24) to confirm.

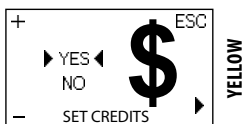

- 5 The option "SET CREDITS" will be displayed, which will allow the number of credits to be manually entered.

- 6 Press the "☉" button (21) to confirm and to access the credit charging page.

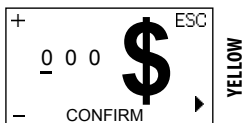

To charge credits:

- 7 Press the "MEMO" (18) or "☉" (20) button to set the desired number.

- 8 Press the "☰" button (24) to move on to the next number (when it gets to the end it will start again from the beginning).

- 9 Repeat steps 7 and 8 until the desired number of credits has been entered.

i Note: You can exit the change menu at any time without saving the setting by pressing the "☉" button (22).

- 10 Press the "☉" button (21) to confirm the number of credits and to exit the menu.

i Note: If "NO" is selected from the "CREDITS" menu, the charged credits will remain in the memory even though they will not be counted each time a coffee is brewed.

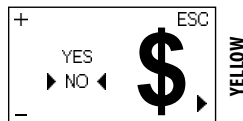

11 CLEANING AND MAINTENANCE



All the operations described in chapter 10 must be performed exclusively by the service provider or a specialised technician, who shall organise all the operating steps and use only suitable means to ensure strict compliance with the safety regulations in force.

11.1 Cleaning Intervals

For improved efficiency, it is advisable to carry out the cleaning and maintenance operations indicated in the following table.

Operation to be carried out	When an alert is shown	Every week	Every month or 500 brewing cycles
Emptying and cleaning the coffee grounds drawer	■		
Water tank cleaning		■	
Brew group cleaning		■	
Brew group lubrication			■
Coffee bean hopper cleaning			■
Descaling	■		

11.2 Brew Group Lubrication

Lubricate the Brew group after approximately 500 cups of coffee or once a month.

The grease to lubricate the brew group and the complete "Service Kit" can be purchased at your local dealer or at authorised service centres.

Before lubricating the brew group, clean it under running water as described in the "Brew Group - Weekly Cleaning" chapter.

1 Lubricate the brew group guides using Saeco grease only.

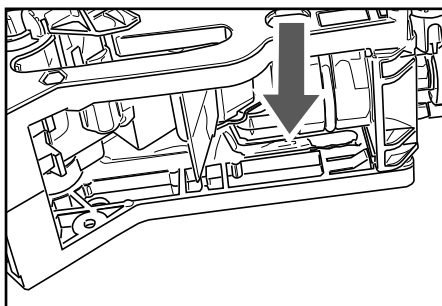

Apply the grease evenly on both side guides.

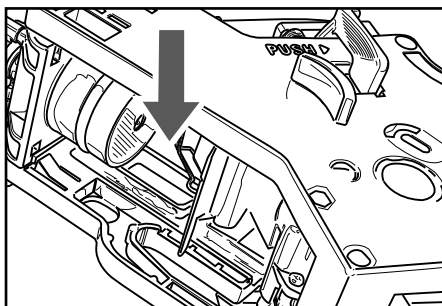

2 Also lubricate the shaft.

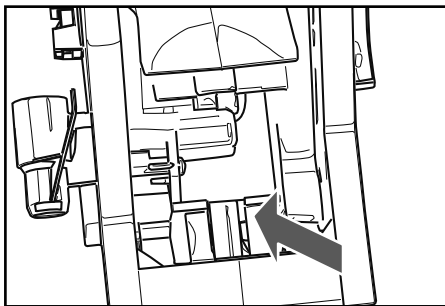
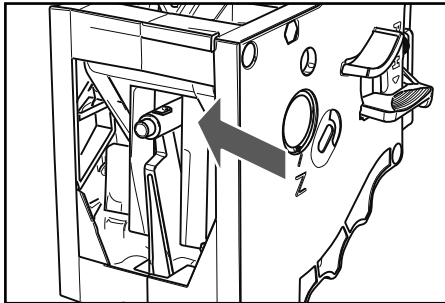

3 Insert the Brew Group into its seat again until it locks into place, WITHOUT pressing the "PUSH" button.

4 Insert the coffee grounds drawer and the drip tray. Close the service door.

11.3 Descaling

Limescale is a natural part of the water used for machine operation.

It needs to be removed regularly as it may clog the water and coffee circuit of your appliance.

The advanced electronics shows on the machine display (with clear icons) when descaling is needed. Just follow the steps described below.

Perform this operation before your appliance stops working due to clear maintenance neglect.

Use the Saeco descaling product only. Its formula has been specifically designed to ensure better machine performance and operation for its whole operating life. If correctly used, it also avoids alterations in the brewed product.

The descaling solution and the complete "Maintenance Kit" may be purchased at your local dealer or at authorised service centres.

Warning! Never drink the descaling solution or any products brewed until the cycle has been completed. Never use vinegar as a descaling solution.

1 Turn on the machine by pressing the ON/OFF button. Wait for the machine to complete the rinse and warm-up process. Remove the Pannarello end part.

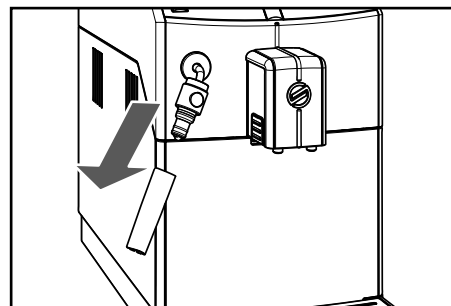

Warning! Remove the "Intenza" filter before adding the descaling solution.

2 Switch to programming mode as described in section 10.1.

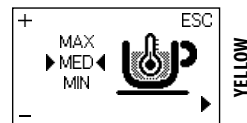

3 Press the "ESC" button (24) until the following menu is displayed:

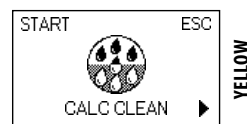

- 4 Press the "MEMO" button (18) to start the DESCALING cycle.

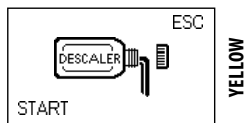

i Note: If this option is confirmed, the whole cycle must be completed. Press the "MEMO" button (22) to exit.

- 5 Pour the entire contents of the bottle of Saeco concentrated descaling solution into the machine's water tank.

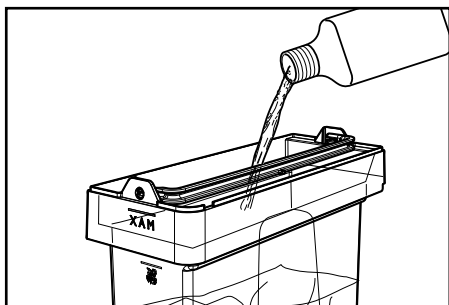

- 6 Fill with fresh drinking water up to the level marked by the "CALC CLEAN" icon.

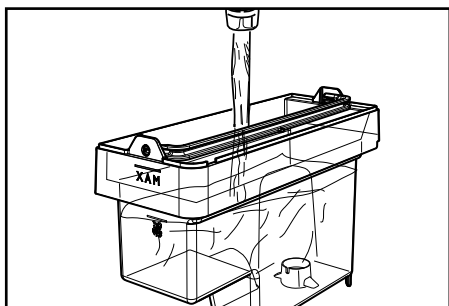

- 7 Place the tank back in the machine.

- 8 Drain any liquids from the drip tray and place it back into the machine (see section 6.3).

- 9 Place a container under the steam/hot water wand and another one under the dispensing spout.

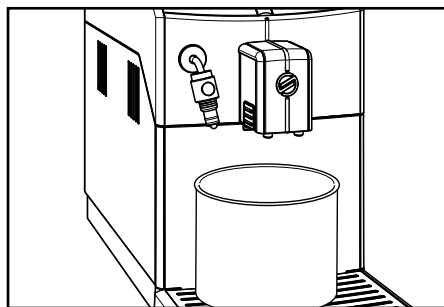

- i** Note: Use a container of at least 1.5 litres capacity.

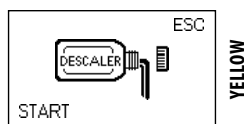

- 10 Press the "MEMO" button (20).

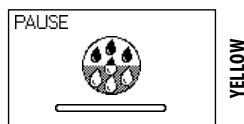

- i** If you do not have a container of this capacity, pause the cycle by pressing the "MEMO" button (18), empty the container, place it back in the machine and re-start the cycle by pressing the "MEMO" button (18).

- 11 At this point, the machine will start dispensing the descaling solution at intervals (the bar shows the cycle progress).

- 12 When the solution in the tank is finished, empty and rinse the tank with fresh drinking water, as indicated by the machine.

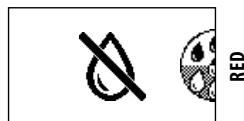

- 13 Empty the containers used to collect the liquid dispensed by the machine.

- 14 Remove any liquids from the drip tray and insert the tray back into the machine.

15 Place a container under the steam/hot water wand and another one under the dispensing spout.

16 Rinse the water tank thoroughly and fill it again with fresh drinking water up to the MAX level.

17 Insert the tank into the machine.



18 Press the "☕" button (18); the machine performs the rinse cycle.

i Note: The rinse cycle can be paused by pressing the "☕" button (18). To resume the cycle, press the "☕" button (18) again. This allows you to empty the container or to leave the machine unattended for a short time.

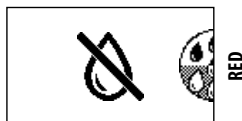

19 When this icon is displayed, the water tank is empty. Repeat steps 13 to 18. Then continue with step 20.

20 When the amount of water needed for the rinse cycle has been completely dispensed, this icon is displayed.

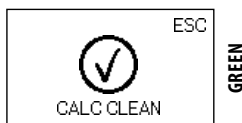

Press the "☕" button (22) to quit the descaling cycle.

i Note: The two rinse cycles are performed in order to have the circuit cleaned with a preset amount of water and ensure proper machine operation. If the water tank is not filled up to MAX level, the machine might require three or more cycles.

21 Once the rinse cycle is complete, the machine carries out the warm-up and rinse cycle to be ready for product brewing.

22 Empty the containers used to collect the liquid dispensed by the machine and reassemble the dispensing spout.

23 Empty the drip tray and place it back.

24 The machine is now ready for use.

25 Reassemble the Pannarello end part.

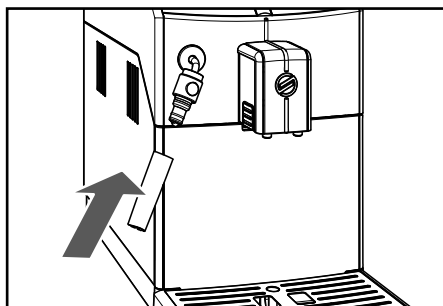

i Note:

- The descaling solution must be disposed of according to the manufacturer's instructions and/or regulations in force in the country of use;
- After completing the descaling cycle, wash the brew group as described in the "Weekly Cleaning of the Brew Group" section in the "Cleaning and Maintenance" chapter;

When the descaling cycle is complete, the drip tray must be emptied.

12 MACHINE DISPOSAL



In compliance with art. 13 of the Italian Legislative Decree dated 25 July 2005, no. 151 "Implementation of the Directives 2002/95/EC, 2002/96/EC and 2003/108/EC on the restriction of the use of certain hazardous substances in electrical and electronic equipment, as well as waste disposal".



The symbol of the crossed-out wheeled bin  on the appliance or its packaging indicates that the product must be disposed of separately from other waste at the end of its operational life.

The user must therefore take the appliance to be disposed of to a suitable recycling centre for electronic and electrotechnical equipment, or alternatively hand it over to the vendor on a one on one exchange, when purchasing a new appliance of similar type. Separating this product for subsequent recycling, treatment and environmentally-friendly disposal will help prevent potential environmental and health risks, and allow the materials which make up the appliance to be re-used and/or recycled. Incorrect or irresponsible disposal of this product could lead to administrative sanctions being imposed on the user in accordance with current regulations.

13 TROUBLESHOOTING

Machine actions	Causes	Solutions
The machine does not turn on.	The machine is not connected to the electric network.	Connect the machine to the electric network.
The drip tray gets filled although no water is drained.	Sometimes water is drained automatically by the machine into the drip tray to manage the rinsing of the circuits and ensure optimum machine performance.	This is a standard operating procedure.
The red  icon is always displayed on the machine.	The coffee grounds drawer has been emptied with the machine off.	The coffee grounds drawer must always be emptied with the machine on. Wait until the  icon is displayed before refitting the drawer.
The coffee is not hot enough.	The cups are cold.	Preheat the cups with hot water.
	The beverage temperature in the programming menu is set on LOW.	Make sure that the temperature in the programming menu is set on NORMAL or HIGH.
No hot water or steam is dispensed.	The hole of the hot water/steam wand is clogged.	Clean the hole of the steam wand using a pin. Make sure that the machine is off and has cooled down before performing this operation.
Coffee does not have enough crema (see note).	The blend is unsuitable, coffee is not freshly roasted or the grind is too coarse.	Change coffee blend or adjust the grind setting as explained in the chapter "Adjusting the Coffee Grinder".
The machine takes a long time to warm up or the amount of water dispensed is too little.	The machine circuit is clogged by limescale.	Descalcify the machine.

Machine actions	Causes	Solutions
The brew group cannot be removed.	The brew group is out of place.	Turn on the machine. Close the service door. The brew group automatically returns to the initial position.
	The coffee grounds drawer is inserted.	Remove the coffee grounds drawer before removing the brew group.
The machine grinds the coffee beans but no coffee is dispensed (see note).	There is no water.	Fill the water tank and prime the circuit (chapter "First Use - Use After a Long Period of Inactivity").
	The brew group is dirty.	Clean the brew group (see "Weekly Cleaning of the Brew Group" chapter).
	The circuit is not primed.	Priming the circuit ("First Use - Use After a Long Period of Inactivity" chapter).
	This might occur when the machine is automatically adjusting the dose.	Brew some cups of coffee.
	The dispensing spout is dirty.	Clean the dispensing spout.
The coffee is too weak (see note).	This might occur when the machine is automatically adjusting the dose.	Brew some cups of coffee.
Coffee is dispensed slowly (see note).	The coffee grind is too fine.	Change coffee blend or adjust the grind as explained in the chapter "Adjusting the Coffee Grinder".
	The circuit is not primed.	Priming the circuit ("First Use - Use After a Long Period of Inactivity" chapter).
	The brew group is dirty.	Clean the brew group (see "Weekly Cleaning of the Brew Group" chapter).
Coffee leaks out of the dispensing spout.	The dispensing spout is clogged.	Clean the dispensing spout and its holes.

Note: These problems can be considered normal if the coffee blend has been changed or if the machine has just been installed.

Please contact our consumer care help line on the phone number listed on the last page of this document for any problems not covered in the above table, or when the suggested solutions do not solve the problem.



421944012411

The manufacturer reserves the right to make changes without prior notice.

